



INSTYTUT TECHNIKI BUDOWLANEJ



Member of



www.eota.eu

European Technical Assessment

ETA-23/0347
of 12/05/2023



General Part

Technical Assessment Body issuing the European Technical Assessment

Instytut Techniki Budowlanej

Trade name of the construction product

TIT VE-200 PRO
TIT VE 200 PRO ARCTIC

Product family to which the construction product belongs

Bonded fasteners for use in concrete

Manufacturer

TOO Energon Service
Chapaeva str., bld. 22
090000 Uralsk
Kazakhstan

Manufacturing plant

TOO Energon Service – Manufacturing plant 1

This European Technical Assessment contains

29 pages including 3 Annexes which form an integral part of this Assessment

This European Technical Assessment is issued in accordance with regulation (EU) No 305/2011, on the basis of

European Assessment Document (EAD)
330499-01-0601 "Bonded fasteners for use in concrete"

This European Technical Assessment is issued by the Technical Assessment Body in its official language. Translations of this European Technical Assessment in other languages shall fully correspond to the original issued document and shall be identified as such.

Communication of this European Technical Assessment, including transmission by electronic means, shall be in full. However, partial reproduction may only be made with the written consent of the issuing Technical Assessment Body. Any partial reproduction has to be identified as such.

Specific Part

1 Technical description of the product

The TIT VE-200 PRO and TIT VE 200 PRO ARCTIC are bonded fasteners (injection type) consisting of an injection mortar cartridge using an applicator gun equipped with a special mixing nozzle and steel element: commercial threaded rod of the sizes M8 to M30 with hexagon nut and washer or reinforcing bar (rebar) from Ø8 to Ø32 mm.

The steel element is placed into a drilled hole previously injected (using an applicator gun) with a mortar with a slow and slight twisting motion. The steel element is anchored by the bond between steel element, mortar and concrete.

An illustration and the description of the products are given in Annex A.

2 Specification of the intended use in accordance with the applicable European Assessment Document (EAD)

The performances given in clause 3 are only valid if the fasteners are used in compliance with the specifications and conditions given in Annex B.

The provisions made in this European Technical Assessment are based on an assumed working life of the fastener of 50 years. The indications given on the working life cannot be interpreted as a guarantee given by the producer, but are to be regarded only as a means for choosing the right products in relation to the expected economically reasonable working life of the works.

3 Performance of the product and references to the methods used for its assessment

3.1 Performance of the product

3.1.1 Mechanical resistance and stability (BWR 1)

Essential characteristic	Performance
Characteristic resistance to tension load and shear load (static and quasi static loading), displacements	See Annex C1 to C7
Characteristic resistance for seismic performance category C1	See Annex C8
Characteristic resistance for seismic performance category C2	See Annex C9

3.1.2 Hygiene, health and the environment (BWR 3)

No performance assessed.

3.2 Methods used for the assessment

The assessment has been made in accordance with EAD 330499-01-0601.

4 Assessment and verification of constancy of performance (AVCP) system applied, with reference to its legal base

According to Decision 96/582/EC of the European Commission the system 1 of assessment and verification of constancy of performance applies (see Annex V to regulation (EU) No 305/2011).

5 Technical details necessary for the implementation of the AVCP system, as provided in the applicable European Assessment Document (EAD)

Technical details necessary for the implementation of the AVCP system are laid down in the control plan deposited in Instytut Techniki Budowlanej.

For type testing the results of the tests performed as part of the assessment for the European Technical Assessment shall be used unless there are changes in the production line or plant. In such cases the necessary type testing has to be agreed between Instytut Techniki Budowlanej and the notified body.

Issued in Warsaw on 12/05/2023 by Instytut Techniki Budowlanej

A handwritten signature in blue ink, appearing to read 'Anna Panek'.

Anna Panek, MSc
Deputy Director of ITB

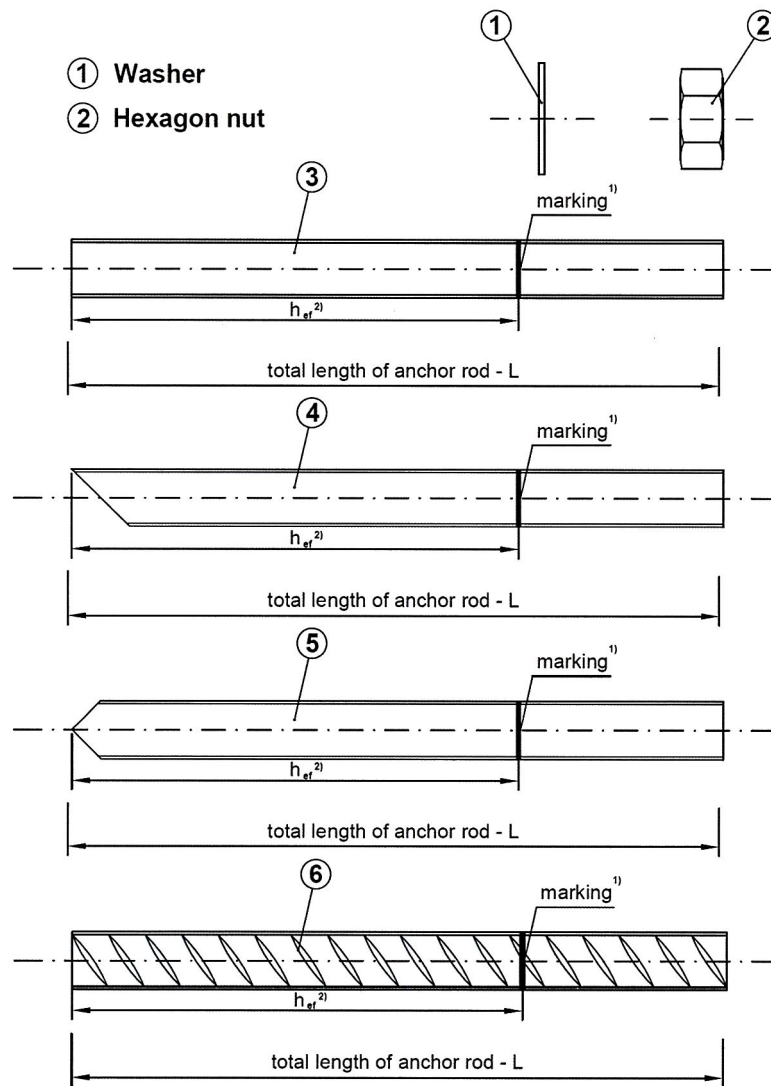

- 3) Version 1 – rod with flat end with marking on h_{ef}
- 4) Version 2 – rod with 45° cutted end with marking on h_{ef}
- 5) Version 3 – rod with V shape end with marking on h_{ef}
- 6) Rebar – ribbed reinforcing bar with marking on h_{ef}

¹⁾ Marking according to clause 1.1 of EAD 330499-01-0601

²⁾ Effective anchorage depth according to Table B1 and B2 (Annex B2 and B3)

TIT VE-200 PRO
TIT VE 200 PRO ARCTIC

Product description
 Steel elements

Annex A1
 of European
 Technical Assessment
 ETA-23/0347

Table A1: Threaded rods

Designation		Material			
Steel, zinc plated					
electroplated $\geq 5 \mu\text{m}$ acc. to EN ISO 4042					
hot-dip galvanized $\geq 40 \mu\text{m}$ acc. to EN ISO 1461					
Threaded rod	Property class	Characteristic steel ultimate strength	Characteristic steel yield strength	Fracture elongation	EN ISO 898-1
	4.8	$f_{uk} \geq 400 \text{ N/mm}^2$	$f_{yk} \geq 320 \text{ N/mm}^2$	$A_5 > 8\%^{1)}$	
	5.8	$f_{uk} \geq 500 \text{ N/mm}^2$	$f_{yk} \geq 400 \text{ N/mm}^2$	$A_5 > 8\%^{1)}$	
	8.8	$f_{uk} \geq 800 \text{ N/mm}^2$	$f_{yk} \geq 640 \text{ N/mm}^2$	$A_5 \geq 12\%^{1)}$	
	10.9	$f_{uk} \geq 1000 \text{ N/mm}^2$	$f_{yk} \geq 900 \text{ N/mm}^2$	$A_5 > 9\%^{1)}$	
Hexagon nut	4	for class 4.8 rods			EN 898-2
	5	for class 5.8 rods			
	8	for class 8.8 rods			
	10	for class 10.9 rods			
Washer	Steel according to EN ISO 7089; corresponding to anchor rod material				
Stainless steel A2		(Materials) 1.4301, 1.4307, 1.4567, 1.4541			
Stainless steel A4		(Materials) 1.4401, 1.4404, 1.4571, 1.4362, 1.4578			
High corrosion resistance stainless steel (HCR)		(Materials) 1.4529, 1.4565			
Threaded rod	Property class	Characteristic steel ultimate strength	Characteristic steel yield strength	Fracture elongation	EN 10088 EN ISO 3506
	50	$f_{uk} \geq 500 \text{ N/mm}^2$	$f_{yk} \geq 210 \text{ N/mm}^2$	$A_5 > 8\%^{1)}$	
	70	$f_{uk} \geq 700 \text{ N/mm}^2$	$f_{yk} \geq 450 \text{ N/mm}^2$	$A_5 \geq 12\%^{1)}$	
	80	$f_{uk} \geq 800 \text{ N/mm}^2$	$f_{yk} \geq 600 \text{ N/mm}^2$	$A_5 \geq 12\%^{1)}$	
Hexagon nut	50	for class 50 rods			EN 10088 EN ISO 3506
	70	for class 70 rods			
	80	for class 80 rods			
Washer	Steel, according to EN 10088; corresponding to anchor rod material				

¹⁾ For seismic performance category C1 and C2, $A_5 > 19\%$

Commercial standard threaded rods may be used, with:

- material and mechanical properties according to Table A3,
- confirmation of material and mechanical properties by inspection certificate 3.1 according to EN-10204:2004,
- marking of the threaded rod with the embedment depth.

Note: Commercial standard threaded rods made of galvanized steel with property class above 8.8 are not permitted in some Member States.

TIT VE-200 PRO TIT VE 200 PRO ARCTIC	Annex A2 of European Technical Assessment ETA-23/0347
Product description Materials (1)	

Table A2: Reinforcing bars (Rebar)

Designation	Material
Rebar according to EN 1992-1-1:2004+AC:2010	Bars and de-coiled rods Class B or C with f_{yk} and k according to EN 1992-1-1:2004+AC:2010 $f_{tk} = f_{tk} = k \times f_{yk}$ Rib height of the bar (h) in the range $0,05d \leq h \leq 0,07d$

Table A3: Injection mortars

Product	Composition
TIT VE-200 PRO TIT VE 200 PRO ARCTIC (two component injection mortars)	Additive: quartz Bonding agent: vinyl ester resin styrene free Hardener: dibenzoyl peroxide

TIT VE-200 PRO
TIT VE 200 PRO ARCTIC

Product description
 Materials (2)

Annex A3
 of European
 Technical Assessment
 ETA-23/0347

coaxial cartridge - sizes from 75 ml to 420 ml

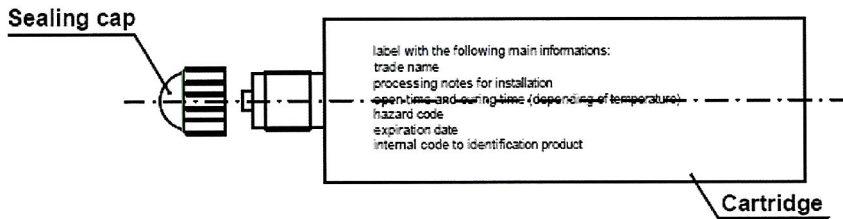

side by side cartridge - sizes from 345 ml to 825 ml

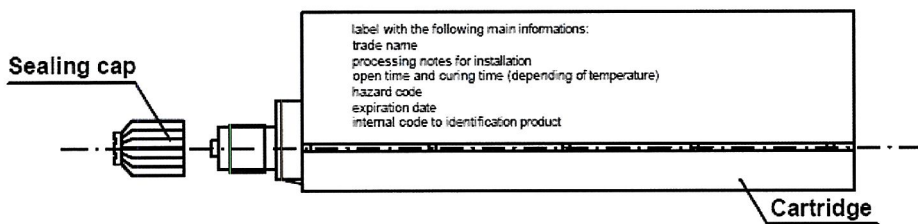

CIC foil cartridge - sizes from 165 ml to 300 ml

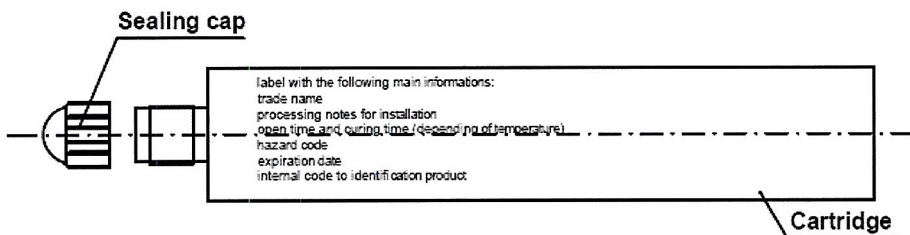

coaxial peeler cartridge - size of 280 ml

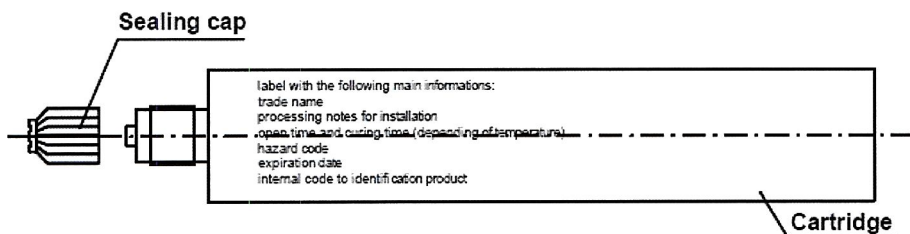

MIXER - the mixer is suitable for each type of cartridge

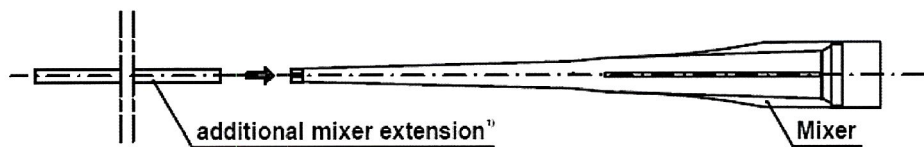

1) Variable length from 380 mm up to 1000 mm

<p>TIT VE-200 PRO TIT VE 200 PRO ARCTIC</p>	<p>Annex A4</p>
<p>Product description Cartridge types and sizes</p>	<p>of European Technical Assessment ETA-23/0347</p>

Specifications of intended use

Use:

The anchors are intended to be used for anchorages for which requirements for mechanical resistance and stability and safety in use in the sense of the Basic Requirement 1 in accordance with regulation (EU) 305/2011 shall be fulfilled and failure of anchorages made with these products would compromise the stability of the works, cause risk to human life and/or lead to considerable economic consequences.

Anchors subject to:

Static and quasi-static loads: sizes from M8 to M30 and from Ø8 to Ø32.

Seismic performance category C1: sizes from M12 to M20, rods with $f_{uk} \leq 800 \text{ N/mm}^2$ and fracture elongation $A_5 \geq 19\%$.

Seismic performance category C2: sizes M12 and M16, rods with $f_{uk} \leq 800 \text{ N/mm}^2$ and fracture elongation $A_5 \geq 19\%$.

Base material:

- Reinforced or unreinforced normal weight concrete of strength class C20/25 at minimum to C50/60 at maximum according to EN 206.
- Uncracked concrete: sizes from M8 to M30 and from Ø8 to Ø32.
- Cracked concrete: sizes from M10 to M20.

Temperature range:

The anchors may be used in the following temperature range:

- -40°C to +40°C (max. short term temperature +40°C and max. long term temperature +24°C).
- -40°C to +80°C (max. short term temperature +80°C and max. long term temperature +50°C).
- -40°C to +120°C (max. short term temperature +120°C and max. long term temperature +72°C).

Use conditions (environmental conditions):

- X1: Structures subject to dry internal conditions: Elements made of galvanized steel (zinc plated or hot dip galvanized) and stainless steel A2, A4 or high corrosion resistance steel (HCR).
- X2: Structures subject to external atmospheric exposure (including industrial and marine environment) and to permanently damp internal condition, if no particular aggressive conditions exist: Elements made of stainless steel A4 or high corrosion resistance steel (HCR).
- X3: Structures subject to external atmospheric exposure (including industrial and marine environment) and to permanently damp internal condition, if other particular aggressive conditions exist. Such particular aggressive conditions are e.g. permanent, alternating immersion in seawater or the splash zone of seawater, chloride atmosphere of indoor swimming pools or atmosphere with chemical pollution (e.g. in desulphurization plants or road tunnels where de-icing materials are used): Elements made of high corrosion resistant steel (HCR).

Installation:

- Dry or wet concrete (use category I1): sizes from M8 to M30 and from Ø8 to Ø32.
- Flooded holes with the exception of seawater (use category I2): sizes from M8 to M30 and from Ø8 to Ø32.
- Installation direction D3 (downward and horizontal and upwards installation): sizes from M8 to M30 and from Ø8 to Ø32.
- The anchors are suitable for hammer drilled holes (HD), for hollow drill bit (HDB) and for compressed air drill (CA): sizes from M8 to M30 and from Ø8 to Ø32.

Design methods:

- Verifiable calculation notes and drawings are prepared taking account of the loads to be anchored. The position of the anchor is indicated on the design drawings (e. g. position of the anchor relative to reinforcement or to supports, etc.).
- Anchorages are designed under the responsibility of an engineer experienced in anchorages and concrete work.
- Anchorages under static or quasi-static loads are designed in accordance to EN 1992-4:2018 and Technical Report TR 055.
- Anchorages under seismic actions are designed in accordance to EN 1992-4:2018 and Technical Report TR 045.

TIT VE-200 PRO TIT VE 200 PRO ARCTIC	Annex B1 of European Technical Assessment ETA-23/0347
Intended use Specifications	

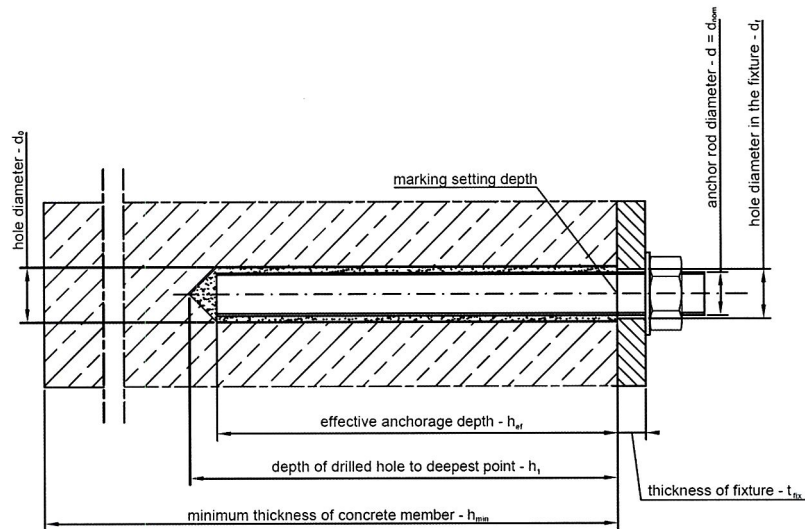

Table B1: Installation data for threaded rods

Size		M8	M10	M12	M16	M20	M24	M27	M30
Nominal drilling diameter	d_0 [mm]	10	12	14	18	24	28	30	35
Maximum diameter hole in the fixture	d_{fix} [mm]	9	12	14	18	22	26	30	33
Effective embedment depth	$h_{ef,min}$ [mm]	60	70	80	100	120	145	145	145
	$h_{ef,max}$ [mm]	160	200	240	320	400	480	540	600
Depth of the drilling hole	h_1 [mm]	$h_{ef} + 5$ mm							
Minimum thickness of the concrete slab	h_{min} [mm]	$h_{ef} + 30$ mm; ≥ 100 mm				$h_{ef} + 2d_0$			
Maximum setting torque moment	T_{fix} [N·m]	10	20	40	80	130	200	250	280
Thickness to be fixed	$t_{fix,min}$ [mm]	> 0							
	$t_{fix,max}$ [mm]	< 1500							
Minimum spacing	s_{min} [mm]	40	50	60	75	100	115	120	140
Minimum edge distance	c_{min} [mm]	40	50	60	75	100	115	120	140

TIT VE-200 PRO
TIT VE 200 PRO ARCTIC

Intended use
 Installation data for threaded rods

Annex B2
 of European
 Technical Assessment
 ETA-23/0347

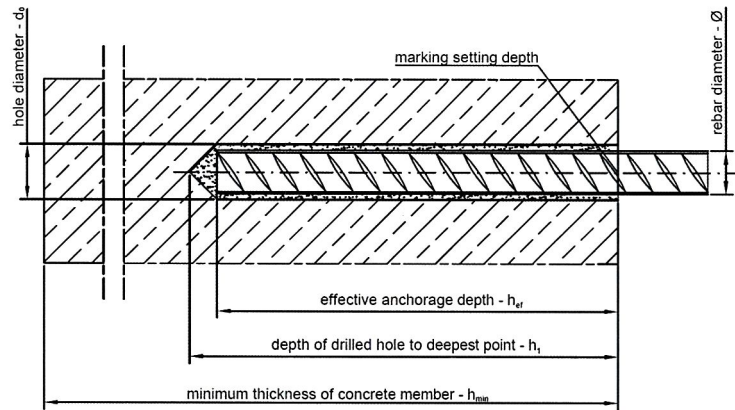
Table B2: Installation data for rebars

Size		Ø8	Ø10	Ø12	Ø14	Ø16	Ø20	Ø25	Ø28	Ø32
Nominal drilling diameter	d_0 [mm]	10 ¹⁾ 12 ¹⁾	12 ¹⁾ 14 ¹⁾	14 ¹⁾ 16 ¹⁾	18	20	25	30	35	40
	Effective embedment depth	$h_{ef,min}$ [mm]	60	70	80	80	100	120	150	180
$h_{ef,max}$ [mm]		160	200	240	280	320	400	500	560	640
Depth of the drilling hole	h_1 [mm]	$h_{ef} + 5 \text{ mm}$								
Minimum thickness of the concrete slab	h_{min} [mm]	$h_{ef} + 30 \text{ mm};$ $\geq 100 \text{ mm}$			$h_{ef} + 2d_0$					
Minimum spacing	s_{min} [mm]	50	60	65	75	80	100	120	140	160
Minimum edge distance	c_{min} [mm]	50	60	65	75	80	100	120	140	160

¹⁾ Each of two given values can be used

TIT VE-200 PRO
TIT VE 200 PRO ARCTIC

Intended use
Installation data for rebars

Annex B3
of European
Technical Assessment
ETA-23/0347

Table B3: Maximum processing time and minimum curing time

TIT VE-200 PRO		
Concrete temperature [C°]	Maximum processing time [min.]	Minimum curing time ¹⁾ [min.]
-10	105	1440
-5	65	840
0	45	420
+5	25	90
+10	16	60
+15	11,5	45
+20	7,5	40
+25	5	35
+30	3	30
+35	2	25
+40	1	20
TIT VE 200 PRO ARCTIC		
Concrete temperature [C°]	Maximum processing time [min.]	Minimum curing time ¹⁾ [min.]
-20	120	2880
-15	90	1500
-10	60	900
-5	40	210
0	25	100
+5	15	70
+10	10	50
+15	7	35
+20	5	30

¹⁾ The minimum time from the end of the mixing to the time when the anchor may be torque or loaded (whichever is longer). Cartridge temperature from +5°C to +30°C. Minimum cartridge temperature of +15°C for application where the concrete temperature is below 0°C.

For wet condition and flooded holes the curing time must be double.

TIT VE-200 PRO
TIT VE 200 PRO ARCTIC

Intended use
Maximum processing time and minimum curing time

Annex B4
of European
Technical Assessment
ETA-23/0347

Manual Blower pump: nominal dimensions

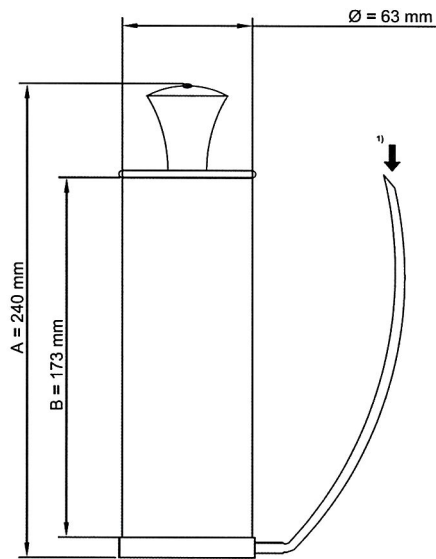

It is possible to use the mixer extensor with the manual blower pump.

However It is possible to blow the hole using the mechanical air system (compressed air) also with the mixer extension

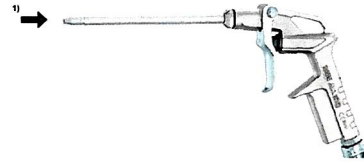

Suitable min pressure 6 bar at 6 m³/h
 Oil-free compressed air
 Recommended air gun with an orifice opening of minimum 3.5 mm in diameter

1) Position to Insert the mixer extension

Mixer extension (from 380 mm to 1000 mm) with nominal diameter 8 or 10 mm

**TIT VE-200 PRO
 TIT VE 200 PRO ARCTIC**

Intended use
 Cleaning tools (1)

Annex B5
 of European
 Technical Assessment
 ETA-23/0347

Table B4: Standard brush diameter for threaded rods

Threaded rod diameter		M8	M10	M12	M16	M20	M24	M27	M30
d_0	Nominal drill hole [mm]	10	12	14	18	24	28	30	35
d_b	Brush diameter [mm]	12	14	16	20	26	30	35	37

Table B5: Standard brush diameter for rebar

Rebar diameter		Ø8		Ø10		Ø12		Ø14
d_0	Nominal drill hole [mm]	10 ¹⁾	12 ¹⁾	12 ¹⁾	14 ¹⁾	14 ¹⁾	16 ¹⁾	18
d_b	Brush diameter [mm]	12	14	14	16	16	18	20

¹⁾ Each of two given values can be used

Table B6: Special brush diameter (mechanical brush) for threaded rods

Threaded rod diameter		M16	M20	M24	M27	M30
d_0	Nominal drill hole [mm]	18	24	28	30	35
d_b	Brush diameter [mm]	20	26	30	32	37

Table B7: Special brush diameter (mechanical brush) for rebar

Threaded rod diameter		Ø8		Ø10		Ø12		Ø14	Ø16	Ø20	Ø25	Ø28	Ø32
d_0	Nominal drill hole [mm]	10 ¹⁾	12 ¹⁾	12 ¹⁾	14 ¹⁾	14 ¹⁾	16 ¹⁾	18	20	25	30	35	40
d_b	Brush diameter [mm]	12	14	14	16	16	18	20	22	27	32	37	42

¹⁾ Each of two given values can be used

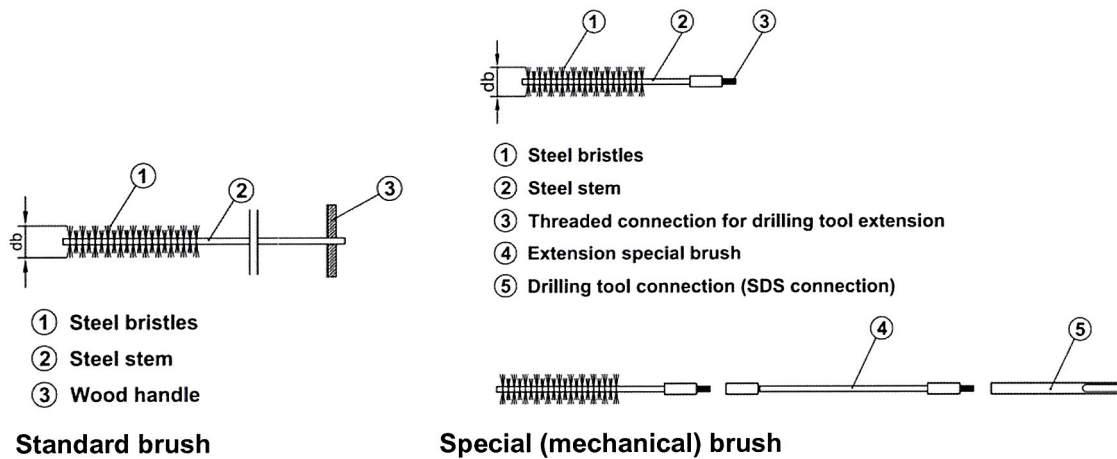

TIT VE-200 PRO
TIT VE 200 PRO ARCTIC

Intended use
Cleaning tools (2)

Annex B6
of European
Technical Assessment
ETA-23/0347

Hollow Drill Bit (HDB)

This drilling method is a hammer drilling method.

This drilling system removes the dust and cleans the bore hole during the drilling operation when used in accordance with the user's manual.

This drilling system include a vacuum cleaner. A suitable dust extraction system must be used.
e.g. Bosch GAS 35 M AFC or a comparable dust extraction system with equivalent performance data.

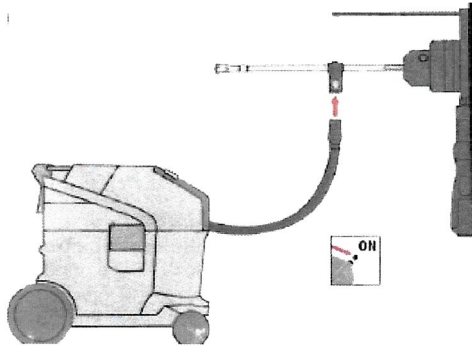

Switch-on the vacuum cleaner before to drill



Table B8: HDB perforation diameter for threaded rods

Threaded rod diameter		M8	M10	M12	M16	M20	M24	M27	M30
d_0	Nominal drill hole [mm]	10	12	14	18	24	28	30	35

Table B9: HDB perforation diameter for rebar

Rebar diameter		Ø8	Ø10	Ø12	Ø14	Ø16	Ø20	Ø25	Ø28
d_0	Nominal drill hole [mm]	10 ¹⁾ 12 ¹⁾	12 ¹⁾ 14 ¹⁾	14 ¹⁾ 16 ¹⁾	18	20	25	30	35

¹⁾ Each of two given values can be used

TIT VE-200 PRO
TIT VE 200 PRO ARCTIC

Intended use
Hollow drill bit (HDB) specification

Annex B7
of European
Technical Assessment
ETA-23/0347

Use the mixer extension (assembled on the standard mixer) for the injection up to 300 mm if necessary.

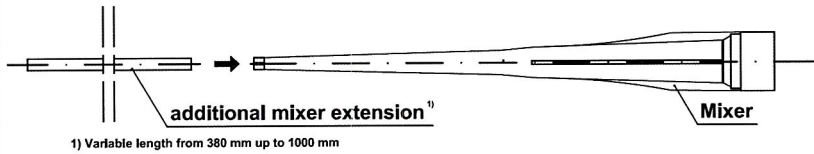

Use this system for special conditions.

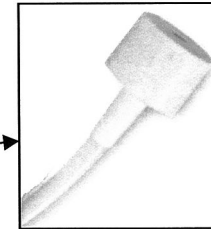
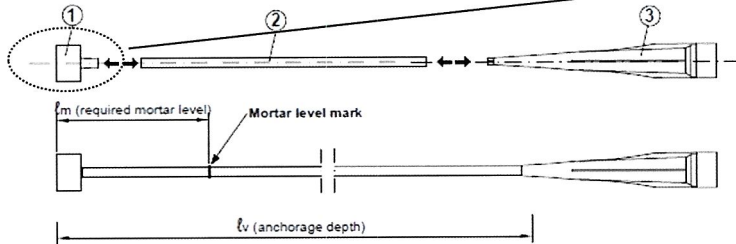

Insert the special mixer extension in the inner diameter of the injection plug up to reach the top of the plug

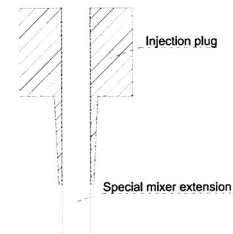

- ① Injection plug (nominal diameter according to the nominal diameter of drilled hole)
- ② Special mixer extension (variable length with external diameter 10 mm)
Mark the required mortar level ℓ_m and embedment depth ℓ_v with tape or marker on the injection extension. Quick estimation: $\ell_m = 1/3 \cdot \ell_v$
Continue injection until the mortar level mark ℓ_m becomes visible.
- ③ Mixer (suitable for all size of cartridge)

These tools allow the application in special conditions:
 - installation with anchorage depth greater than 300 mm;
 - overhead installation.

For these applications it is recommended the use of pneumatic or battery dispenser.

System assembled

- ① Injection plug
- ② Special mixer extension
- ③ Mixer
- ④ Cartridge
- ⑤ Sample of dispenser

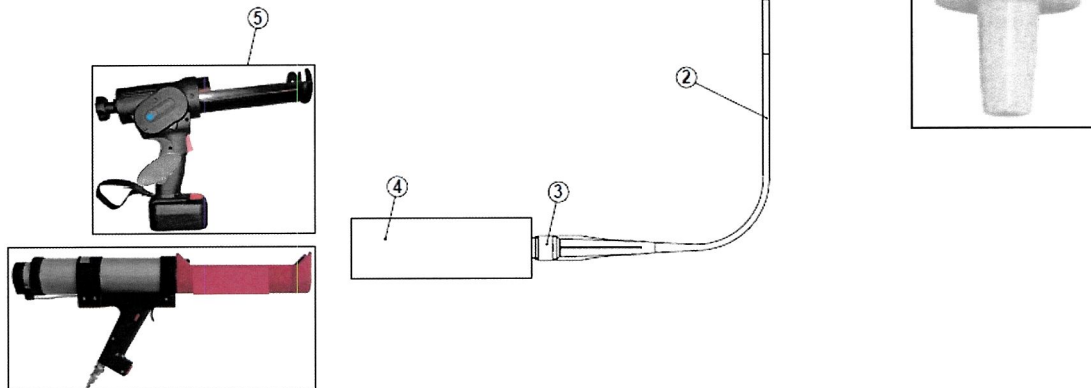





**TIT VE-200 PRO
TIT VE 200 PRO ARCTIC**

Intended use
Tools for installation (1)

Annex B8
of European
Technical Assessment
ETA-23/0347

Table B10: Mortar injection pumps

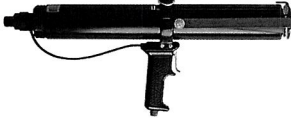
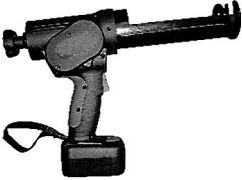
Pumps (injection dispensers)	Cartridges	Types
 <i>Manual</i>	420 ml 400 ml 380 ml	Manual (up to 300 mm anchorage depth)
 <i>Manual</i>	345 ml 300 ml 280 ml 165 ml	Manual (up to 300 mm anchorage depth)
 <i>Manual</i>	300 ml 280 ml 165 ml	Manual (up to 300 mm anchorage depth)
 <i>Pneumatic</i>	825 ml	Pneumatic (up to 640 mm anchorage depth)
 <i>Pneumatic</i>	420 ml 400 ml 380 ml	Pneumatic (up to 640 mm anchorage depth)
 <i>Battery</i>	420 ml 400 ml 380 ml 345 ml 300 ml	Battery (up to 640 mm anchorage depth)

TIT VE-200 PRO
TIT VE 200 PRO ARCTIC

Intended use
Tools for installation (2)

Annex B9
of European
Technical Assessment
ETA-23/0347

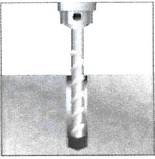
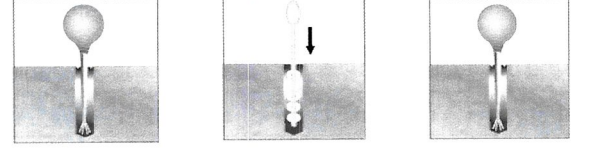
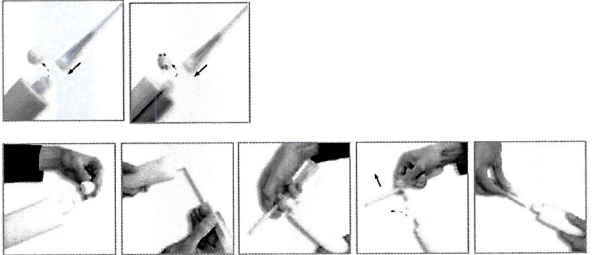
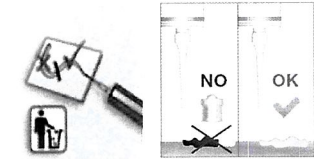
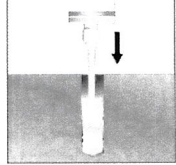
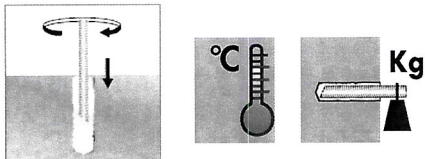
<p>1</p>		<p>Drill the hole with the correct diameter and depth using a rotary percussive machine. Check the perpendicularity of the hole during the drilling operation. In case of use of hollow drill bit (Annex B7) proceed directly to the clause 3.</p>
<p>2</p>	 <p>4x blower manual pump 4x standard brush 4x blower manual pump if necessary use a mixer extension for the blower operation (see Annex B5)</p>	<p>Clean the hole from drilling dust: the hole shall be cleaned by at least 4 blowing operations, by at least 4 brushing operations followed again by at least 4 blowing operations; before brushing clean the brush and check (see Annex B6, standard brush) if the brush diameter is sufficient. For the blower tools see Annex B5.</p>
<p>3</p>		<p>For coaxial, peeler and side by side cartridges unscrew the front cup, screw on the mixer and insert the cartridge into the gun. For CIC sizes, unscrew the front cup, pull-out the steel closing clip according to the following operation:</p> <ol style="list-style-type: none"> 1) Insert the mixer in the eye of the plastic extractor; 2) Pull the extractor to unhook the steel closing clip of the foil. In the version without the extractor cut the foil pack. <p>After that screw on the mixer and insert the cartridge in the gun.</p>
<p>4</p>		<p>Before starting to use the cartridge, eject a first part of the product, being sure that the two components are completely mixed. The complete mixing is reached only after that the product, obtained by mixing the two components, comes out from the mixer with a uniform colour.</p>
<p>5</p>	 <p>if necessary, use a mixer extension for the injection (see Annex B8)</p>	<p>Fill the drilled hole uniformly starting from the drilled hole bottom, in order to avoid entrapment of the air; remove the mixer slowly bit by bit during pressing-out; filling the drill hole with a quantity of the injection mortar corresponding to 2/3 of the drill hole depth.</p>
<p>6</p>	 <p>ATTENTION: Steel elements dry and free oil and other contaminants</p>	<p>Insert immediately the steel element (threaded rod or rebar), marked according to the proper anchorage depth, slowly and with a slight twisting motion, removing excess of injection mortar around the steel element. Observe the processing time according Annex B4. Wait the curing time according Annex B4.</p>
<p>TIT VE-200 PRO TIT VE 200 PRO ARCTIC</p>		<p>Annex B10 of European Technical Assessment ETA-23/0347</p>
<p>Intended use Installation instruction up to 300 mm depth</p>		

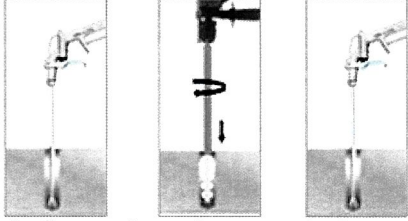
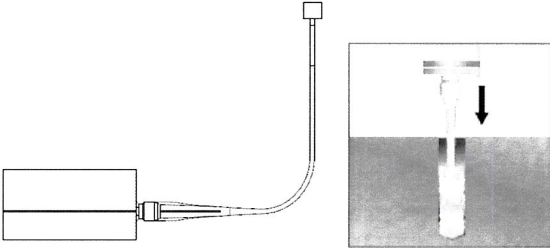
1	<p>See clause 1 Annex B10. In case of use of hollow drill bit (HDB) proceed directly to the clause 3.</p>	
2	 <p>4 x 5 seconds 4x 4 x 5 seconds ATTENTION: compressed air free oil</p>	<p>Clean the hole from drilling dust: the hole shall be cleaned by at least 4 blowing operations (5 seconds for single operation) with compressed air, by at least 4 brushing operations with special brush followed again by at least 4 blowing operations (5 seconds for single operation) with compressed air. Before brushing clean the brush and check if the brush diameter is sufficient.</p>
3	<p>See clause 3 Annex B10</p>	
4	<p>See clause 4 Annex B10</p>	
5		<p>Before starting the injection, assemble the system according to Annex B8. After that, fill the drilled hole uniformly from the drilled hole bottom, in order to avoid entrapment of the air; remove the special mixer extension with injection plug slowly bit by bit during pressing-out; filling the drill hole with a quantity of the injection mortar corresponding to 2/3 of the drill hole depth. Procedure for overhead installation are detailed in Annex B12.</p>
6	<p>See clause 6 Annex B10</p>	
<p>TIT VE-200 PRO TIT VE 200 PRO ARCTIC</p>		<p>Annex B11</p>
<p>Intended use Installation instruction up to 640 mm depth</p>		<p>of European Technical Assessment ETA-23/0347</p>

Overhead installation procedure

In addition to standard procedure, for overhead installation, following the below procedure

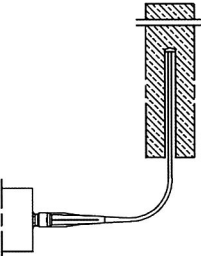
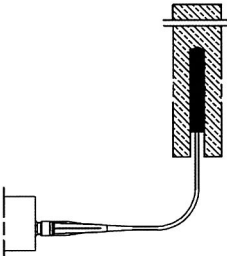
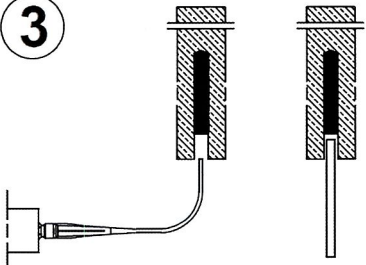
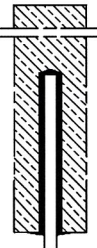
<p>①</p> 	<p>1 - Start injection</p> <p>Inject from the bottom of the hole. Use battery or pneumatic dispenser if the anchorage depth is greater than 200 mm.</p>
<p>②</p> 	<p>2 - Injection phase</p> <p>Inject the product about 2/3 of the hole depth. Remove the mixer extension slowly bit by bit during pressing-out.</p>
<p>③</p> 	<p>3 - End injection</p> <p>Remove the mixer extension. Insert immediately the steel element (turn the steel element during the insertion).</p>
<p>④</p> 	<p>4 - End installation</p> <p>To avoid the slipping of the steel element during the open time of the product (due to the steel element own weight) use a temporary interlocking element (for ex. wedge of wood)</p>

TIT VE-200 PRO
TIT VE 200 PRO ARCTIC

Intended use
Overhead installation instruction

Annex B12
of European
Technical Assessment
ETA-23/0347

Table C1: Characteristic values for steel tension resistance and steel shear resistance of threaded rods

Size			M8	M10	M12	M16	M20	M24	M27	M30
Steel failure – characteristic tension resistance										
Steel class 4.8	$N_{Rk,s}$	[kN]	15	23	34	63	98	141	183	224
Steel class 5.8	$N_{Rk,s}$	[kN]	18	29	42	78	122	176	229	280
Steel class 8.8	$N_{Rk,s}$	[kN]	29	46	67	126	196	282	367	449
Steel class 10.9	$N_{Rk,s}$	[kN]	37	58	84	157	245	353	459	561
Stainless steel A2, A4, HCR class 50	$N_{Rk,s}$	[kN]	18	29	42	78	122	176	229	280
Stainless steel A2, A4, HCR class 70	$N_{Rk,s}$	[kN]	26	41	59	110	171	247	321	392
Stainless steel A4, HCR class 80	$N_{Rk,s}$	[kN]	29	46	67	126	196	282	367	449
Steel failure – characteristic tension resistance – partial factor										
Steel class 4.8	$\gamma_{Ms,N}^{1)}$	[-]					1,50			
Steel class 5.8	$\gamma_{Ms,N}^{1)}$	[-]					1,50			
Steel class 8.8	$\gamma_{Ms,N}^{1)}$	[-]					1,50			
Steel class 10.9	$\gamma_{Ms,N}^{1)}$	[-]					1,40			
Stainless steel A2, A4, HCR class 50	$\gamma_{Ms,N}^{1)}$	[-]					2,86			
Stainless steel A2, A4, HCR class 70	$\gamma_{Ms,N}^{1)}$	[-]					1,87			
Stainless steel A4, HCR class 80	$\gamma_{Ms,N}^{1)}$	[-]					1,60			
Steel failure – characteristic shear resistance without lever arm										
Steel class 4.8	$V_{Rk,s}^0$	[kN]	7	12	17	31	49	71	92	112
Steel class 5.8	$V_{Rk,s}^0$	[kN]	9	14	21	39	61	88	115	140
Steel class 8.8	$V_{Rk,s}^0$	[kN]	15	23	34	63	98	141	184	224
Steel class 10.9	$V_{Rk,s}^0$	[kN]	18	29	42	78	122	176	230	280
Stainless steel A2, A4, HCR class 50	$V_{Rk,s}^0$	[kN]	9	14	21	39	61	88	115	140
Stainless steel A2, A4, HCR class 70	$V_{Rk,s}^0$	[kN]	13	20	29	55	86	124	160	196
Stainless steel A4, HCR class 80	$V_{Rk,s}^0$	[kN]	15	23	34	63	98	141	184	224
Steel failure – characteristic shear resistance with lever arm										
Steel class 4.8	$M_{Rk,s}^0$	[Nm]	15	30	52	133	260	449	666	900
Steel class 5.8	$M_{Rk,s}^0$	[Nm]	19	37	65	166	324	561	832	1125
Steel class 8.8	$M_{Rk,s}^0$	[Nm]	30	60	105	266	519	898	1331	1799
Steel class 10.9	$M_{Rk,s}^0$	[Nm]	37	75	131	333	649	1123	1664	2249
Stainless steel A2, A4, HCR class 50	$M_{Rk,s}^0$	[Nm]	19	37	66	166	324	561	832	1124
Stainless steel A2, A4, HCR class 70	$M_{Rk,s}^0$	[Nm]	26	52	92	233	454	786	1165	1574
Stainless steel A4, HCR class 80	$M_{Rk,s}^0$	[Nm]	30	60	105	266	519	898	1331	1799
Steel failure – characteristic shear resistance – partial factor										
Steel class 4.8	$\gamma_{Ms,V}^{1)}$	[-]					1,25			
Steel class 5.8	$\gamma_{Ms,V}^{1)}$	[-]					1,25			
Steel class 8.8	$\gamma_{Ms,V}^{1)}$	[-]					1,25			
Steel class 10.9	$\gamma_{Ms,V}^{1)}$	[-]					1,50			
Stainless steel A2, A4, HCR class 50	$\gamma_{Ms,V}^{1)}$	[-]					2,38			
Stainless steel A2, A4, HCR class 70	$\gamma_{Ms,V}^{1)}$	[-]					1,56			
Stainless steel A4, HCR class 80	$\gamma_{Ms,V}^{1)}$	[-]					1,33			

Fracture elongation threaded rod for seismic category C1 and C2 must be $A_s \geq 19\%$.

Steel classes 10.9 are not covered for seismic application.

¹⁾ In the absence of national regulation

TIT VE-200 PRO
TIT VE 200 PRO ARCTIC

Performances
Characteristic values for steel tension resistance and steel shear resistance
- threaded rods

Annex C1
of European
Technical Assessment
ETA-23/0347

Table C2: Characteristic values for tension resistance in uncracked concrete under static and quasi-static loads - threaded rods

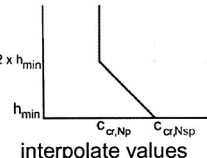
Size	M8	M10	M12	M16	M20	M24	M27	M30		
Steel failure										
Characteristic resistance	$N_{Rk,s}$	[kN]	See Annex C1 – Table C1							
Partial factor	$\gamma_{Ms,N}^{1)}$	[-]	See Annex C1 – Table C1							
Combined pull-out and concrete cone failure in uncracked concrete C20/25										
Characteristic bond resistance temperature range -40°C / +40°C	$\tau_{Rk,ucr}$	[N/mm ²]	16,0	12,0	12,0	12,0	9,5	9,5	8,0	8,0
Characteristic bond resistance temperature range -40°C / +80°C	$\tau_{Rk,ucr}$	[N/mm ²]	11,0	8,5	8,5	8,5	7,0	7,0	6,0	6,0
Characteristic bond resistance temperature range -40°C / +120°C	$\tau_{Rk,ucr}$	[N/mm ²]	6,0	4,5	4,5	4,5	4,0	4,0	3,0	3,0
Increasing factor for C30/37	ψ_c	[-]	1,12							
Increasing factor for C40/50			1,23							
Increasing factor for C50/60			1,30							
Concrete cone failure										
Factor for uncracked concrete	$k_{ucr,N}$	[-]	11,0							
Edge distance	$c_{cr,N}$	[mm]	$1,5 h_{ef}$							
Spacing	$s_{cr,N}$	[mm]	$3,0 h_{ef}$							
Splitting failure										
Edge distance	$c_{cr,Nsp}$	[mm]	If $h = h_{min}$							
			$2,5 \cdot h_{ef}$		$2,0 \cdot h_{ef}$			$1,5 \cdot h_{ef}$		
			If $h_{min} < h < 2 \cdot h_{min}$							
										
			if $h \geq 2 \cdot h_{min}$							
			$c_{cr,Np}$							
Spacing	$s_{cr,Nsp}$	[mm]	$2 \cdot c_{cr,sp}$							
Installation factor for combined pull-out, concrete cone and splitting failure										
Installation factors for category I1 ¹⁾	γ_{inst}	[-]	1,0							
Installation factors for category I2 ¹⁾			1,2							

¹⁾ In the absence of national regulation

TIT VE-200 PRO
TIT VE 200 PRO ARCTIC
Performances

Characteristic values for tension resistance in uncracked concrete under static and quasi-static loads - threaded rods

Annex C2
 of European
 Technical Assessment
 ETA-23/0347

Table C3: Characteristic values for tension resistance in cracked concrete under static and quasi-static loads - threaded rods

Size			M10	M12	M16	M20
Steel failure						
Characteristic resistance	$N_{Rk,s}$	[kN]	See Annex C1 – Table C1			
Partial factor	$\gamma_{Ms,N}^{1)}$	[-]	See Annex C1 – Table C1			
Combined pull-out and concrete cone failure in cracked concrete C20/25						
Characteristic bond resistance temperature range -40°C / +40°C	$\tau_{Rk,cr}$	[N/mm ²]	9,0	9,0	9,0	6,5
Characteristic bond resistance temperature range -40°C / +80°C	$\tau_{Rk,cr}$	[N/mm ²]	6,5	6,5	6,5	4,5
Characteristic bond resistance temperature range -40°C / +120°C	$\tau_{Rk,cr}$	[N/mm ²]	3,5	3,5	3,5	2,5
Increasing factor for C30/37	ψ_c	[-]	1,12			
Increasing factor for C40/50			1,23			
Increasing factor for C50/60			1,30			
Concrete cone failure						
Factor for cracked concrete	$k_{cr,N}$	[-]	7,7			
Edge distance	$C_{cr,N}$	[mm]	1,5 h_{ef}			
Spacing	$S_{cr,N}$	[mm]	3,0 h_{ef}			
Splitting failure						
Edge distance	$C_{cr,Nsp}$	[mm]	If $h = h_{min}$			
			$2,5 \cdot h_{ef}$	$2,0 \cdot h_{ef}$	$1,5 \cdot h_{ef}$	
			If $h_{min} < h < 2 \cdot h_{min}$			
			<p>interpolate values</p>			
			if $h \geq 2 \cdot h_{min}$			
Spacing	$S_{cr,Nsp}$	[mm]	$2 \cdot C_{cr,sp}$			
Installation factor for combined pull-out, concrete cone and splitting failure						
Installation factors for category I1 ¹⁾	γ_{inst}	[-]	1,0			
Installation factors for category I2 ¹⁾			1,2			

¹⁾ In the absence of other national regulation

**TIT VE-200 PRO
TIT VE 200 PRO ARCTIC**

Performances
Characteristic values for tension resistance in cracked concrete under static and quasi-static loads - threaded rods

Annex C3
of European
Technical Assessment
ETA-23/0347



Table C4: Characteristic values for shear resistance in uncracked and cracked concrete under static and quasi-static loads - threaded rods

Size	M8	M10	M12	M16	M20	M24	M27	M30	
Steel failure without lever arm									
Characteristic resistance	$V_{Rk,s}^0$	[kN]	See Annex C1 – Table C1						
Partial factor	$\gamma_{Ms,V}^{1)}$	[-]	See Annex C1 – Table C1						
Ductility factor	k_7	[-]	1,0						
Steel failure with lever arm									
Characteristic resistance	$M_{Rk,s}^0$	[kN]	See Annex C1 – Table C1						
Partial factor	$\gamma_{Ms,V}^{1)}$	[-]	See Annex C1 – Table C1						
Concrete pry out failure									
Factor	k_8	[-]	2,0						
Installation factor	γ_{inst}	[-]	1,0						
Concrete edge failure									
Effective length of anchor under shear loading	l_f	[-]	$l_f = h_{ef}$ and $\leq 12 d_{nom}$				$l_f = h_{ef}$ and $\leq \max(8 d_{nom}, 300 \text{ mm})$		
Installation factor	γ_{inst}	[-]	1,0						

¹⁾ In the absence of other national regulation

TIT VE-200 PRO TIT VE 200 PRO ARCTIC	Annex C4 of European Technical Assessment ETA-23/0347
Performances Characteristic values for shear resistance in uncracked and cracked concrete under static and quasi-static loads - threaded rods	

Table C5: Characteristic values for tension resistance in uncracked concrete under static and quasi-static loads - rebar

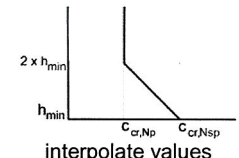
Size			Ø8	Ø10	Ø12	Ø14	Ø16	Ø20	Ø25	Ø28	Ø32
Steel failure											
Characteristic resistance	$N_{Rk,s}$	[kN]	$A_s \times f_{uk}^{2)}$								
Cross section area	A_s	[mm ²]	50	79	113	154	201	314	491	616	804
Partial factor	$\gamma_{Ms,N}^{1)}$	[-]	1,4								
Combined pull-out and concrete cone failure in uncracked concrete C20/25											
Characteristic bond resistance temperature range -40°C / +40°C	$\tau_{Rk,ucr}$	[N/mm ²]	14,0	13,0	13,0	12,0	10,0	9,5	9,5	8,5	7,5
Characteristic bond resistance temperature range -40°C / +80°C	$\tau_{Rk,ucr}$	[N/mm ²]	10,0	9,5	9,0	9,0	7,5	7,0	7,0	6,0	5,5
Characteristic bond resistance temperature range -40°C / +120°C	$\tau_{Rk,ucr}$	[N/mm ²]	5,5	5,0	5,0	5,0	4,0	4,0	4,0	3,5	3,0
Increasing factor for C30/37	ψ_c	[-]	1,12								
Increasing factor for C40/50			1,23								
Increasing factor for C50/60			1,30								
Concrete cone failure											
Factor for uncracked concrete	$k_{ucr,N}$	[-]	11,0								
Edge distance	$C_{cr,N}$	[mm]	$1,5 h_{ef}$								
Spacing	$S_{cr,N}$	[mm]	$3,0 h_{ef}$								
Splitting failure											
Edge distance	$C_{cr,Nsp}$	[mm]	If $h = h_{min}$								
			$2,5 \cdot h_{ef}$			$2,0 \cdot h_{ef}$			$1,5 \cdot h_{ef}$		
			If $h_{min} < h < 2 \cdot h_{min}$								
											
			if $h \geq 2 \cdot h_{min}$								
			$C_{cr,Np}$								
Spacing	$S_{cr,Nsp}$	[mm]	$2 \cdot C_{cr,sp}$								
Installation factor for combined pull-out, concrete cone and splitting failure											
Installation factors for category I1 ¹⁾	γ_{inst}	[-]	1,0								
Installation factors for category I2 ¹⁾			1,2								

¹⁾ In the absence of other national regulation

²⁾ f_{uk} shall be taken from the specifications of reinforcing bars

TIT VE-200 PRO
TIT VE 200 PRO ARCTIC

Performances

Characteristic values for tension resistance in uncracked concrete under static and quasi-static loads - rebar

Annex C5
of European
Technical Assessment
ETA-23/0347

Table C6: Characteristic values for shear resistance in uncracked concrete under static and quasi-static loads - rebar

Size			Ø8	Ø10	Ø12	Ø14	Ø16	Ø20	Ø25	Ø28	Ø32	
Steel failure without lever arm												
Characteristic resistance	$V_{Rk,s}^0$	[kN]	$0,5 \times A_s \times f_{uk}^{2)}$									
Partial factor	$\gamma_{Ms,V}^{1)}$	[-]	1,5									
Cross section area	A_s	[mm ²]	50	79	113	154	201	314	491	616	804	
Ductility factor	k_7	[-]	1,0									
Steel failure with lever arm												
Characteristic resistance	$M_{Rk,s}^0$	[kN]	$1,2 \times W_{el} \times f_{uk}^{2)}$									
Elastic section modulus	W_{el}	[mm ³]	50	98	170	269	402	785	1534	2155	3217	
Partial factor	$\gamma_{Ms,V}^{1)}$	[-]	1,5									
Concrete pry out failure												
Factor	k_8	[-]	2,0									
Installation factor	γ_{inst}	[-]	1,0									
Concrete edge failure												
Effective length of anchor under shear loading	l_f	[-]	$l_f = h_{ef} \text{ and } \leq 12 d_{nom}$						$l_f = h_{ef} \text{ and } \leq \max(8 d_{nom}; 300 \text{ mm})$			
Installation factor	γ_{inst}	[-]	1,0									

¹⁾ In the absence of other national regulation

²⁾ f_{uk} shall be taken from the specifications of reinforcing bars

TIT VE-200 PRO
TIT VE 200 PRO ARCTIC

Performances
Characteristic values for shear resistance in uncracked concrete under static and quasi-static loads - rebar

Annex C6
of European
Technical Assessment
ETA-23/0347

Table C7. Displacement under tension loads for uncracked concrete under static and quasi-static loads – threaded rods

Size			M8	M10	M12	M16	M20	M24	M27	M30
Characteristic displacement in uncracked concrete C20/25 to C50/60 under tension loads										
Service load ¹⁾	F	[kN]	9,6	10,8	14,3	23,8	29,6	42,4	40,4	44,4
Displacement	δ_{N0}	[mm]	0,30	0,30	0,35	0,35	0,35	0,40	0,40	0,45
	$\delta_{N\infty}$	[mm]	0,85	0,85	0,85	0,85	0,85	0,85	0,85	0,85

Table C8: Displacement under tension loads for cracked concrete under static and quasi-static loads – threaded rods

Size			M10	M12	M16	M20
Characteristic displacement in cracked concrete C20/25 to C50/60 under tension loads						
Service load ¹⁾	F	[kN]	9,5	14,3	21,4	23,8
Displacement	δ_{N0}	[mm]	0,50	0,50	0,70	0,60
	$\delta_{N\infty}$	[mm]	0,85	0,85	0,85	0,85

Table C9: Displacement under shear loads for uncracked and cracked concrete under static and quasi-static loads – threaded rods

Size			M8	M10	M12	M16	M20	M24	M27	M30
Characteristic displacement in cracked and uncracked concrete C20/25 to C50/60 under shear loads										
Service load ¹⁾	F	[kN]	3,7	5,8	8,4	15,7	24,5	35,3	45,5	55,6
Displacement	δ_{V0}	[mm]	2,0	2,0	2,0	2,0	2,0	2,0	2,0	2,0
	$\delta_{V\infty}$	[mm]	3,0	3,0	3,0	3,0	3,0	3,0	3,0	3,0

Table C10: Displacement under tension loads for uncracked concrete under static and quasi-static loads – rebar

Size			Ø8	Ø10	Ø12	Ø14	Ø16	Ø20	Ø25	Ø28	Ø32
Characteristic displacement in uncracked concrete C20/25 to C50/60 under tension loads											
Service load ¹⁾	F	[kN]	10,1	13,6	17,2	20,1	23,9	41,2	53,3	64,1	67,3
Displacement	δ_{N0}	[mm]	0,33	0,33	0,40	0,41	0,42	0,45	0,45	0,47	0,48
	$\delta_{N\infty}$	[mm]	0,85	0,85	0,85	0,85	0,85	0,85	0,85	0,85	0,85

Table C11: Displacement under shear loads for uncracked concrete under static and quasi-static loads – rebar

Size			Ø8	Ø10	Ø12	Ø14	Ø16	Ø20	Ø25	Ø28	Ø32
Characteristic displacement in uncracked concrete C20/25 to C50/60 under shear loads											
Service load ¹⁾	F	[kN]	13,2	20,6	29,6	40,3	52,7	82,3	128,6	161,3	210,6
Displacement	δ_{V0}	[mm]	2,0	2,0	2,0	2,0	2,0	2,0	2,0	2,0	2,0
	$\delta_{V\infty}$	[mm]	3,0	3,0	3,0	3,0	3,0	3,0	3,0	3,0	3,0

¹⁾ These values are suitable for each temperature range and categories specified in Annex B1

TIT VE-200 PRO
TIT VE 200 PRO ARCTIC

Performances
 Displacement under service loads

Annex C7
 of European
 Technical Assessment
 ETA-23/0347

Table C12: Characteristic values for tension resistance for seismic performance category C1 - threaded rods

Size			M12	M16	M20
Steel failure					
Characteristic resistance	$N_{Rk,s,eq,C1}$	[kN]	$1,0 \times N_{Rk,s}$		
Partial factor ¹⁾	$\gamma_{Ms,N}$ ¹⁾	[-]	See Annex C1 – Table C1		
Combined pull-out and concrete cone failure					
Characteristic bond resistance temperature range -40°C / +40°C	$\tau_{Rk,C1}$	[N/mm ²]	4,2	3,7	3,7
Characteristic bond resistance temperature range -40°C / +80°C	$\tau_{Rk,C1}$	[N/mm ²]	3,0	2,7	2,7
Characteristic bond resistance temperature range -40°C / +120°C	$\tau_{Rk,C1}$	[N/mm ²]	1,6	1,4	1,4
Increasing factor for C30/37	ψ_c	[-]	1,0		
Increasing factor for C40/50					
Increasing factor for C50/60					
Installation factors for category I1 ¹⁾	γ_{inst}	[-]	1,0		
Installation factors for category I2 ¹⁾			1,2		

¹⁾ In the absence of other national regulation

Table C13: Characteristic values for shear resistance for seismic performance category C1 - threaded rods

Size			M12	M16	M20
Steel failure					
Characteristic resistance	$V_{Rk,s,eq,C1}$	[kN]	$0,7 \times V_{Rk,s}^0$		
Partial factor ¹⁾	$\gamma_{Ms,V}$ ¹⁾	[-]	See Annex C1 – Table C1		

¹⁾ In the absence of other national regulation

Table C14: Reduction factor for annular gap

Reduction factor for annular gap					
Without annular gap filling	α_{gap}	[-]	0,5		
With annular gap filling	α_{gap}	[-]	1,0		

TIT VE-200 PRO
TIT VE 200 PRO ARCTIC

Performances
Characteristic resistance under tension and shear loads for threaded rod for seismic action category C1

Annex C8
of European
Technical Assessment
ETA-23/0347

Table C15: Characteristic values for tension resistance for seismic performance category C2 - threaded rods

Size			M12	M16
Steel failure				
Characteristic resistance	$N_{Rk,s,eq,C2}$	[kN]	$1,0 \times N_{Rk,s}$	
Partial factor ¹⁾	$\gamma_{Ms,N}$ ¹⁾	[-]	See Annex C1 – Table C1	
Combined pull-out and concrete cone failure				
Characteristic bond resistance temperature range -40°C / +40°C	$\tau_{Rk,eq,C2}$	[N/mm ²]	1,6	1,7
Characteristic bond resistance temperature range -40°C / +80°C	$\tau_{Rk,eq,C2}$	[N/mm ²]	1,2	1,2
Characteristic bond resistance temperature range -40°C / +120°C	$\tau_{Rk,eq,C2}$	[N/mm ²]	0,6	0,7
Increasing factor for C30/37	ψ_c	[-]	1,0	
Increasing factor for C40/50				
Increasing factor for C50/60				
Installation factors for category I1 ¹⁾	γ_{inst}	[-]	1,0	
Installation factors for category I2 ¹⁾			1,2	

¹⁾ In the absence of other national regulation

Table C16: Characteristic values for shear resistance for seismic performance category C2 - threaded rods

Size			M12	M16
Steel failure				
Characteristic shear resistance	$V_{Rk,s,eq,C2}$	[kN]	$0,53 \times V_{Rk,s}^0$	$0,46 \times V_{Rk,s}^0$
Partial factor ¹⁾	$\gamma_{Ms,V}$ ¹⁾	[-]	See Annex C1 – Table C1	

¹⁾ In the absence of other national regulation

Table C17: Reduction factor for annular gap

Reduction factor for annular gap				
Without annular gap filling	α_{gap}	[-]	0,5	
With annular gap filling	α_{gap}	[-]	1,0	

Table C18: Displacements under tensile and shear loads for seismic performance category C2 - threaded rods

Size			M12	M16
Displacements for tensile and shear load for seismic performance category C2				
Displacement in tensile at damage limitation state	$\delta_{N,eq,C2}$ (DLS)	[mm]	0,20	0,23
Displacement in tensile at ultimate limit state	$\delta_{N,eq,C2}$ (ULS)	[mm]	0,33	1,04
Displacement in shear at damage limitation state	$\delta_{V,eq,C2}$ (DLS)	[mm]	2,01	0,70
Displacement in shear at ultimate limit state	$\delta_{V,eq,C2}$ (ULS)	[mm]	4,68	2,12

TIT VE-200 PRO
TIT VE 200 PRO ARCTIC

Performances
Characteristic resistance and displacements under tension and shear loads for threaded rod for seismic performance category C2

Annex C9
of European
Technical Assessment
ETA-23/0347